



# SDB0703 SERIES - SMD Power Inductors



## PART NUMBERING SYSTEM

<b>SDB</b>	<b>0703</b>	<b>-</b>	<b>1R0M</b>	<b>- LF</b>
TYPE	DIMENSIONS		INDUCTANCE	LEAD FREE

## SHAPES AND DIMENSIONS

UNIT : mm

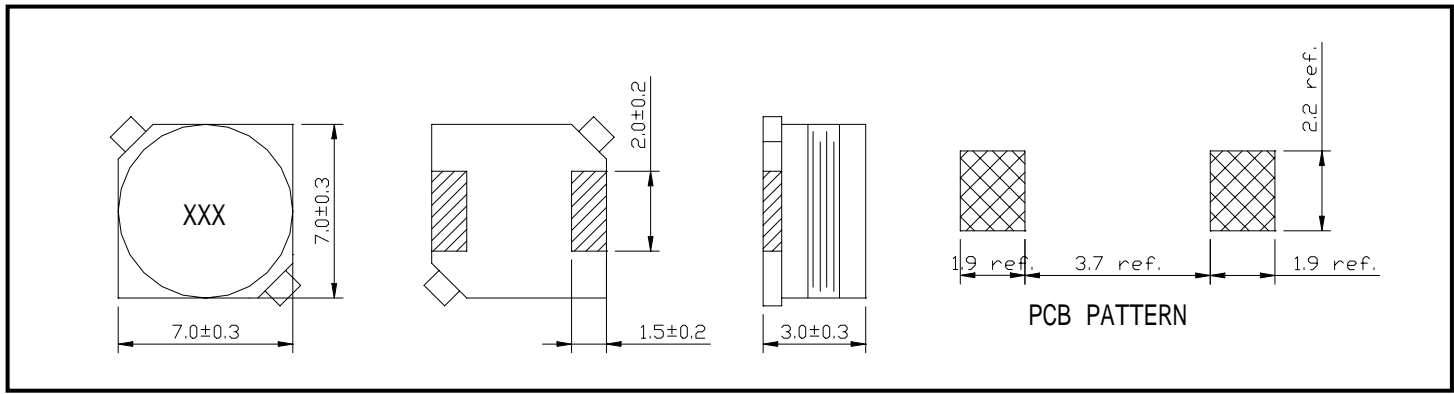

## PACKAGING SPECIFICATION

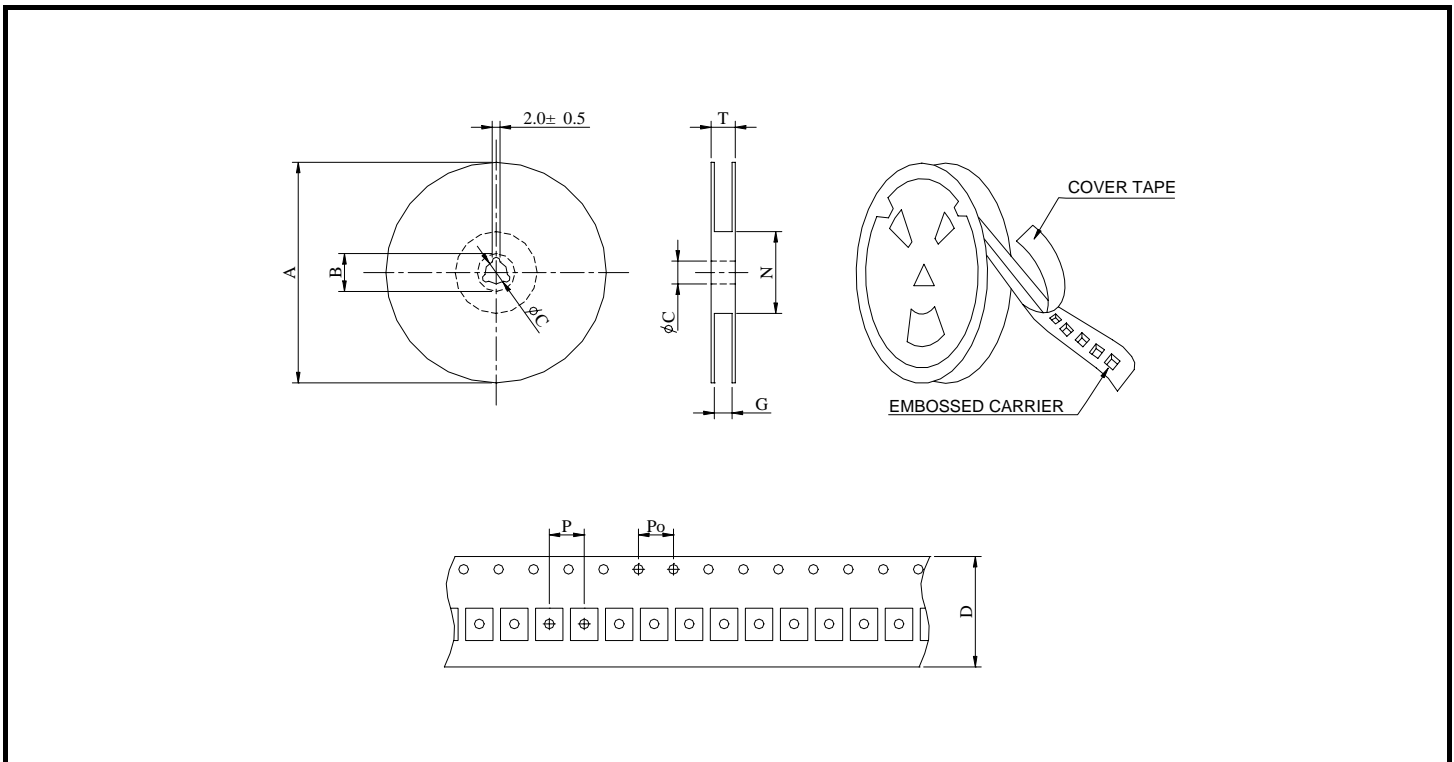

SERIES	STAYLE	Q ' TY (PCS)	DIMENSIONS (m/m)								
			A	B±0.8	C±0.5	D	G <sup>+0</sup>	N <sup>0</sup>	P	Po	T
<b>SDB0703</b>	13-16	1000	330	21	13	16	18	50	12	4	22.4



## SDB0703 SERIES - SMD Power Inductors



### SPECIFICATION TABLE

PART NUMBER	INDUCTANCE ( $\mu$ H)	DCR ( ) (Max.)	IDC ( A ) (Max.)	TEST FREQ. ( f )
SDB0703-1R0M-LF	1.0 $\pm$ 20%	0.020	3.20	100KHz
SDB0703-1R8M-LF	1.8 $\pm$ 20%	0.025	2.80	100KHz
SDB0703-2R2M-LF	2.2 $\pm$ 20%	0.035	2.50	100KHz
SDB0703-3R3M-LF	3.3 $\pm$ 20%	0.040	2.20	100KHz
SDB0703-4R7M-LF	4.7 $\pm$ 20%	0.045	2.00	100KHz
SDB0703-6R8M-LF	6.8 $\pm$ 20%	0.060	1.60	100KHz
SDB0703-100M-LF	10 $\pm$ 20%	0.080	1.40	100KHz
SDB0703-120M-LF	12 $\pm$ 20%	0.085	1.30	100KHz
SDB0703-150M-LF	15 $\pm$ 20%	0.110	1.10	100KHz
SDB0703-180M-LF	18 $\pm$ 20%	0.130	1.05	100KHz
SDB0703-220M-LF	22 $\pm$ 20%	0.150	1.00	100KHz
SDB0703-270M-LF	27 $\pm$ 20%	0.190	0.95	100KHz
SDB0703-330M-LF	33 $\pm$ 20%	0.210	0.85	100KHz
SDB0703-390M-LF	39 $\pm$ 20%	0.270	0.75	100KHz
SDB0703-470M-LF	47 $\pm$ 20%	0.310	0.70	100KHz
SDB0703-560M-LF	56 $\pm$ 20%	0.390	0.65	100KHz
SDB0703-680M-LF	68 $\pm$ 20%	0.430	0.60	100KHz
SDB0703-820M-LF	82 $\pm$ 20%	0.490	0.50	100KHz
SDB0703-101M-LF	100 $\pm$ 20%	0.650	0.45	100KHz
SDB0703-121M-LF	120 $\pm$ 20%	0.700	0.40	100KHz
SDB0703-151M-LF	150 $\pm$ 20%	0.850	0.35	100KHz
SDB0703-181M-LF	180 $\pm$ 20%	1.100	0.33	100KHz
SDB0703-221M-LF	220 $\pm$ 20%	1.250	0.30	100KHz
SDB0703-271M-LF	270 $\pm$ 20%	1.450	0.28	100KHz
SDB0703-331M-LF	330 $\pm$ 20%	2.000	0.25	100KHz
SDB0703-391M-LF	390 $\pm$ 20%	2.250	0.23	100KHz
SDB0703-471M-LF	470 $\pm$ 20%	2.600	0.22	100KHz
SDB0703-561M-LF	560 $\pm$ 20%	3.700	0.20	100KHz
SDB0703-681M-LF	680 $\pm$ 20%	4.300	0.18	100KHz
SDB0703-821M-LF	820 $\pm$ 20%	4.900	0.16	100KHz
SDB0703-102M-LF	1000 $\pm$ 20%	5.600	0.15	100KHz

DC current at which the inductance drops 10% (typ) from its value without current.

Operating temperature range -40°C to +85°C

Electrical specifications at 25°C.