



# SDS5022M SERIES ~ SMD Shielded Power Inductors



RoHS Compliant

***New Products***

## PART NUMBERING SYSTEM

<b>SDS</b>	<b>5 0 2 2 M</b>	—	<b>1 0 0 M</b>	—	<b>LF</b>
TYPE	DIMENSIONS		INDUCTANCE		LEAD FREE

## SHAPES AND DIMENSIONS

UNIT : mm

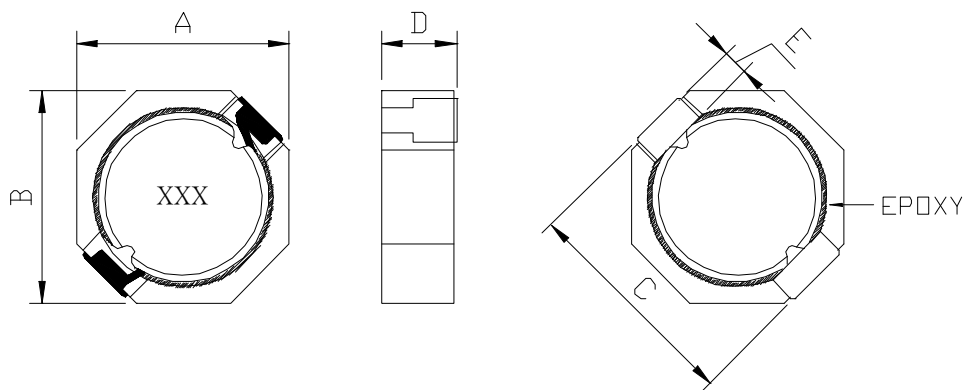

A=5.20 Max. B=5.20 Max. C=5.80 Ref. D=2.20 Max. E=0.60 Ref.

## RECOMMENDED PATTERNS

UNIT : mm

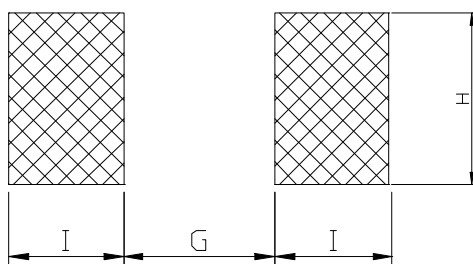

G= 3.20 H= 2.00 I = 1.50

## FEATURES

- Low profile ( 2.20mm max. height ) and 5.2mm max. square.
- Magnetically shielded and High Current with low DC resistance .
- Suitable as inductors for Cellular phone .
- Ideal for a variety of DC-DC converter inductor .
- Most suitable for portable electronic equipment requiring low profile and high density mounting .



## SDS5022M SERIES ~ SMD Shielded Power Inductors



RoHS Compliant

### New Products

#### SPECIFICATION TABLE

PART NUMBER	INDUCTANCE ( $\mu$ H)	DCR (m $\Omega$ ) (Max.)	Isat (A) (Max.)	I <sub>rms</sub> (A) (Max.)	TEST FREQ. ( f )
SDS5022M-1R2N-LF	1.2 $\pm$ 30%	25	4.30	4.20	100KHz
SDS5022M-1R8N-LF	1.8 $\pm$ 30%	32	3.60	3.80	100KHz
SDS5022M-2R2N-LF	2.2 $\pm$ 30%	40	3.20	3.40	100KHz
SDS5022M-3R3N-LF	3.3 $\pm$ 30%	60	2.50	2.70	100KHz
SDS5022M-4R7N-LF	4.7 $\pm$ 30%	81	2.00	2.30	100KHz
SDS5022M-100M-LF	10 $\pm$ 20%	160	1.40	1.70	100KHz
SDS5022M-220M-LF	22 $\pm$ 20%	320	0.90	1.20	100KHz

- Isat : DC current at which the inductance drops 30%(typ) from its value without current.
- I<sub>rms</sub> : Average current for 40°C temperature rise from 20°C ambient.
- Operating temperature range -40°C to +105°C
- Electrical specifications at 20°C .

#### PACKAGING SPECIFICATION

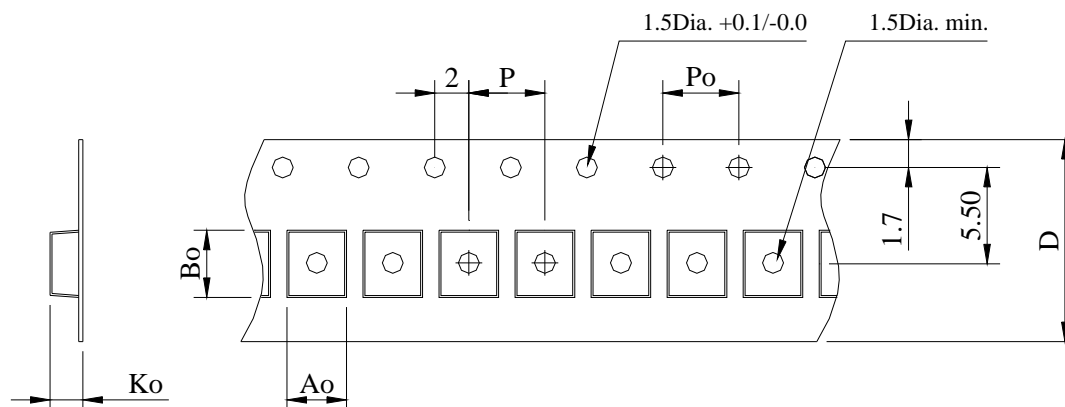

STAYLE	Q' TY (PCS)	DIMENSIONS (m/m)					
		Ao	Bo	Ko	P	Po	D $\pm$ 0.3
13"	2,000	5.72	5.72	2.40	8.00	4.00	12.0



# SDS5022M SERIES ~ *New Products*



RoHS Compliant

## SMD Shielded Power Inductors

### TYPICAL INDUCTANCE VS. FREQUENCY

**SDS5022M-1R2N-LF**

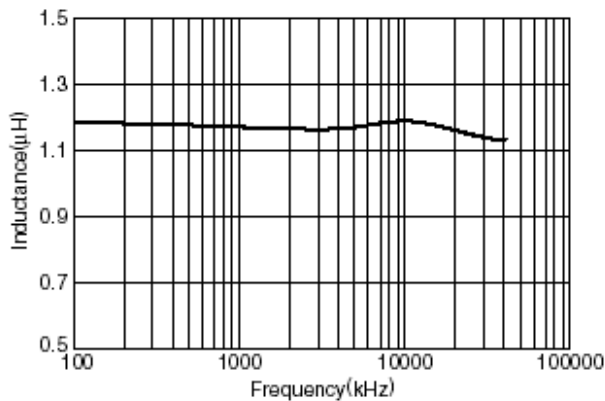

**SDS5022M-1R8N-LF**

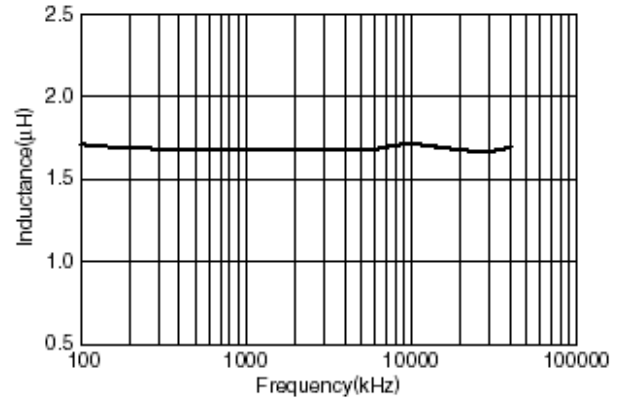

**SDS5022M-2R2N-LF**

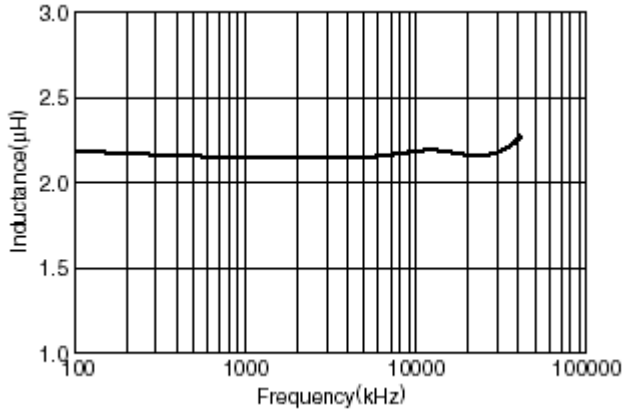

**SDS5022M-3R3N-LF**

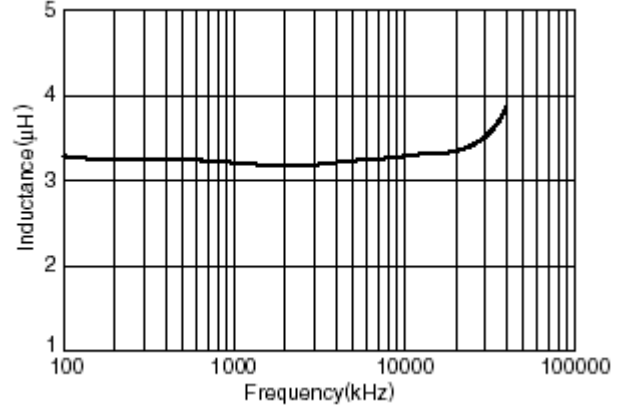

**SDS5022M-4R7N-LF**

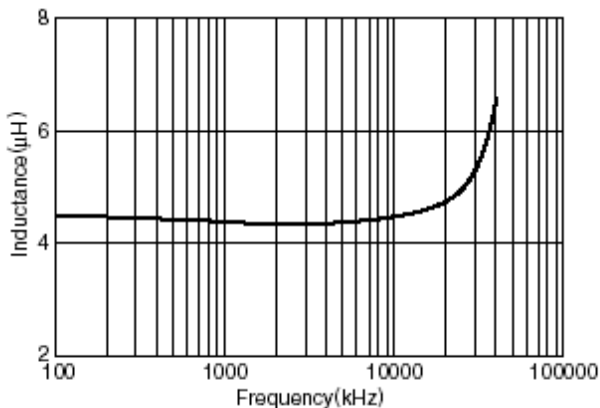

**SDS5022M-100M-LF**

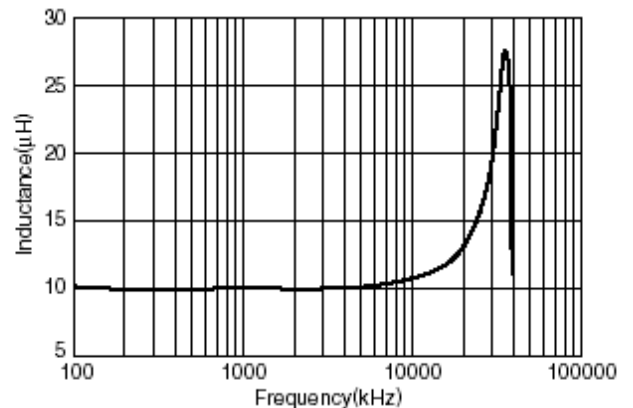



# SDS5022M SERIES ~ **New Products**

## SMD Shielded Power Inductors



RoHS Compliant

### TYPICAL INDUCTANCE VS. FREQUENCY

SDS5022M-220M-LF

