



SBS0604 SERIES ~ Shielded SMD Power Inductors



RoHS Compliant

PART NUMBERING SYSTEM

SBS	0604	—	100M	—	LF
TYPE	DIMENSIONS		INDUCTANCE		LEAD FREE

SHAPES AND DIMENSIONS

UNIT : mm

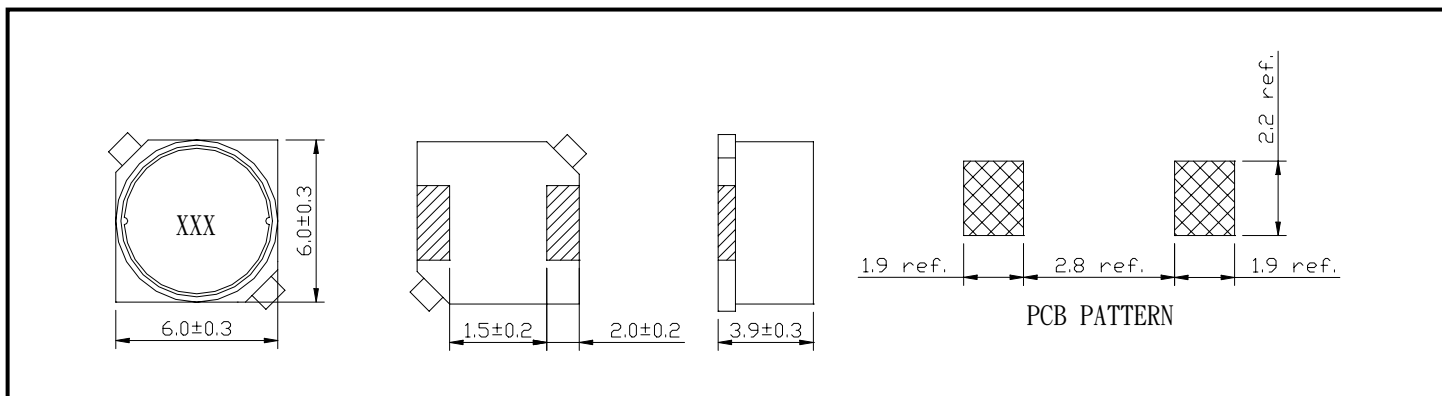

PACKAGING SPECIFICATION

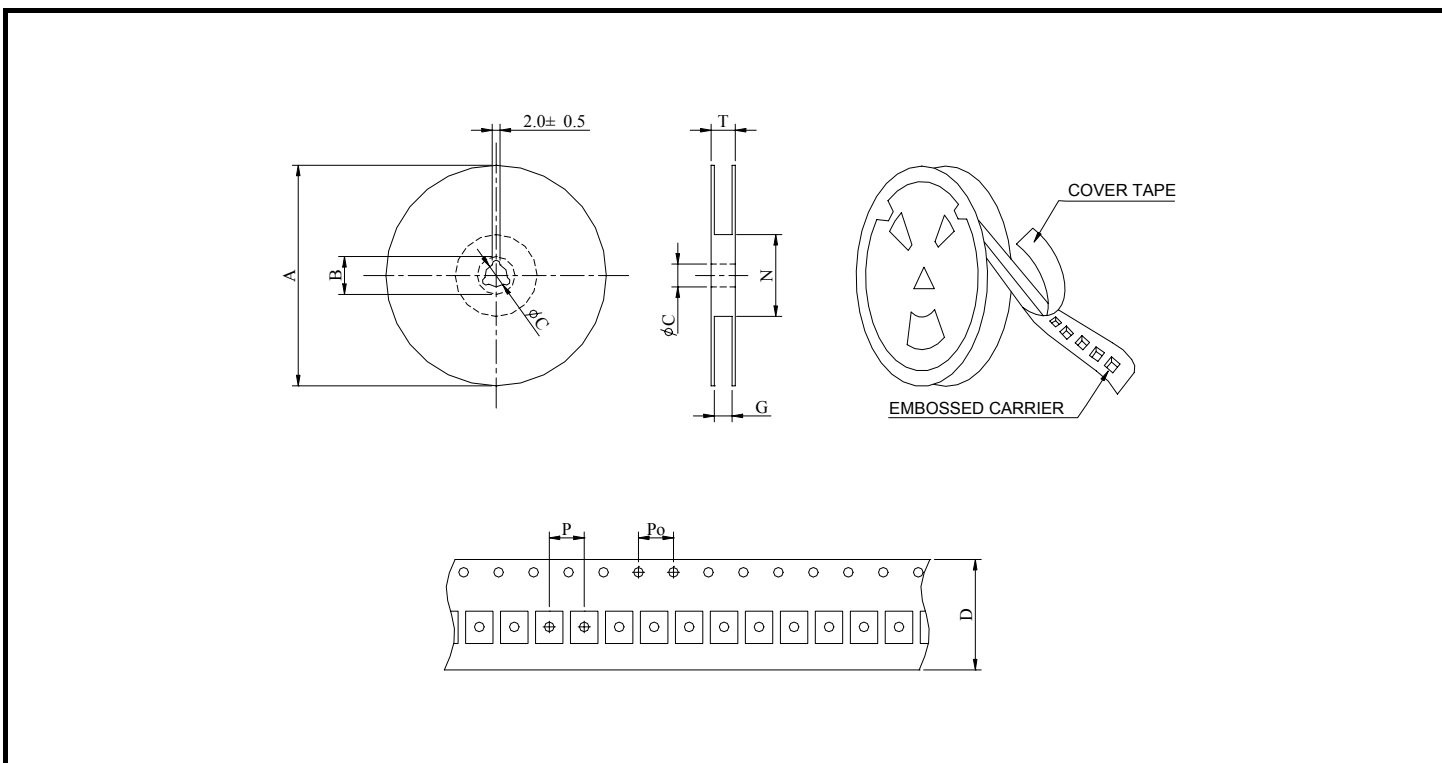

SERIES	STAYLE	Q' TY (PCS)	DIMENSIONS (m/m)								
			A	B ± 0.8	C ± 0.5	D	G $^{+0}$	N 0	P	P $_0$	T
SBS0604	13-16	1000	330	21	13	16	18	50	12	4	22.4



SBS0604 SERIES ~ Shielded SMD Power Inductors



RoHS Compliant

SPECIFICATION TABLE

PART NUMBER	INDUCTANCE (μ H)	DCR (Ω) (Max.)	IDC (A) (Max.)	TEST FREQ. (f)
SBS0604-1R0M-LF	1.0 \pm 20%	0.022	2.50	100KHz
SBS0604-1R5M-LF	1.5 \pm 20%	0.025	2.20	100KHz
SBS0604-2R2M-LF	2.2 \pm 20%	0.030	1.90	100KHz
SBS0604-3R3M-LF	3.3 \pm 20%	0.035	1.70	100KHz
SBS0604-4R7M-LF	4.7 \pm 20%	0.050	1.30	100KHz
SBS0604-6R8M-LF	6.8 \pm 20%	0.055	1.10	100KHz
SBS0604-100M-LF	10 \pm 20%	0.065	1.00	100KHz
SBS0604-120M-LF	12 \pm 20%	0.090	0.90	100KHz
SBS0604-150M-LF	15 \pm 20%	0.100	0.80	100KHz
SBS0604-180M-LF	18 \pm 20%	0.110	0.70	100KHz
SBS0604-220M-LF	22 \pm 20%	0.150	0.65	100KHz
SBS0604-270M-LF	27 \pm 20%	0.170	0.60	100KHz
SBS0604-330M-LF	33 \pm 20%	0.220	0.55	100KHz
SBS0604-390M-LF	39 \pm 20%	0.240	0.50	100KHz
SBS0604-470M-LF	47 \pm 20%	0.300	0.47	100KHz
SBS0604-560M-LF	56 \pm 20%	0.340	0.42	100KHz
SBS0604-680M-LF	68 \pm 20%	0.390	0.40	100KHz
SBS0604-820M-LF	82 \pm 20%	0.500	0.35	100KHz
SBS0604-101M-LF	100 \pm 20%	0.570	0.32	100KHz
SBS0604-121M-LF	120 \pm 20%	0.630	0.30	100KHz
SBS0604-151M-LF	150 \pm 20%	0.900	0.27	100KHz
SBS0604-181M-LF	180 \pm 20%	0.990	0.25	100KHz
SBS0604-221M-LF	220 \pm 20%	1.150	0.22	100KHz
SBS0604-271M-LF	270 \pm 20%	1.550	0.20	100KHz
SBS0604-331M-LF	330 \pm 20%	1.760	0.18	100KHz
SBS0604-391M-LF	390 \pm 20%	2.600	0.17	100KHz
SBS0604-471M-LF	470 \pm 20%	3.000	0.16	100KHz
SBS0604-561M-LF	560 \pm 20%	3.300	0.15	100KHz
SBS0604-681M-LF	680 \pm 20%	3.700	0.13	100KHz
SBS0604-821M-LF	820 \pm 20%	4.900	0.12	100KHz
SBS0604-102M-LF	1000 \pm 20%	5.700	0.11	100KHz

- DC current at which the inductance drops 10% (typ) from its value without current.
- Operating temperature range -20°C to +85°C
- Electrical specifications at 25°C.